



DID YOU KNOW



BASIC FASTENER MEASUREMENTS

Standard Fasteners are basically measured / specified by the nominal thread diameter (D1) x Nominal Length.

HEXAGON HEAD BOLTS/SET SCREWS

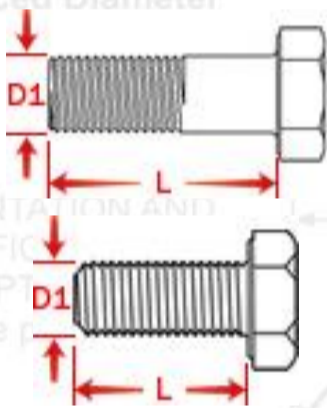

MACHINE SCREWS

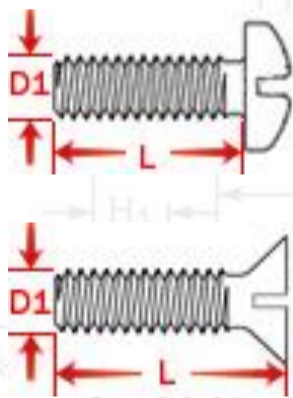

CUP HEAD BOLT & COACH SCREWS

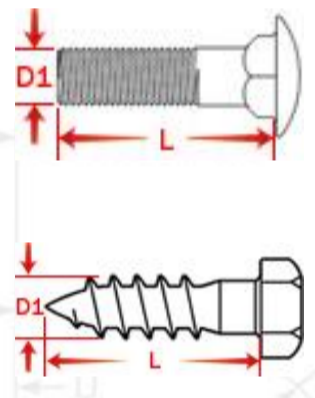

SOCKET SCREWS

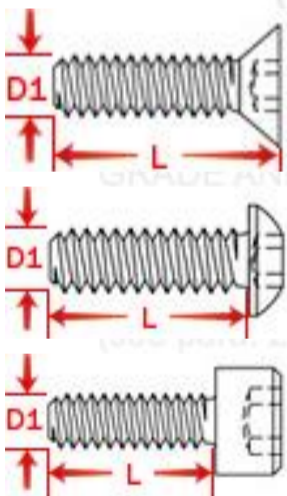

SOCKET SHOULDER SCREWS

Shoulder Screws are measured/specified by the shoulder diameter (DS) X Shoulder Length (L).
To avoid doubt, it is better to also specify the thread detail (d) as well.

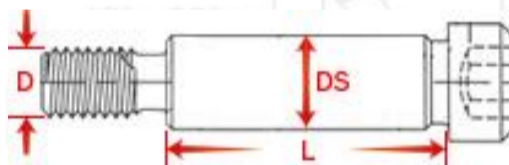

RIVETS

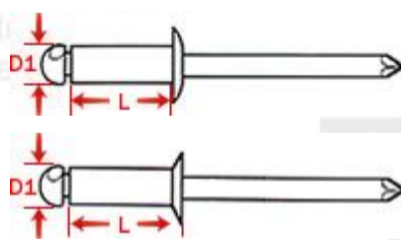

WASHERS

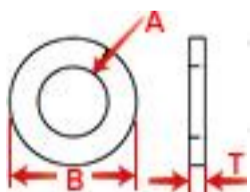

The "Fastener Black Book" Contains over 160 pages of invaluable information.
Tables, Standards, Illustrations, Conversion Charts, Formulae, Tolerances and Much More

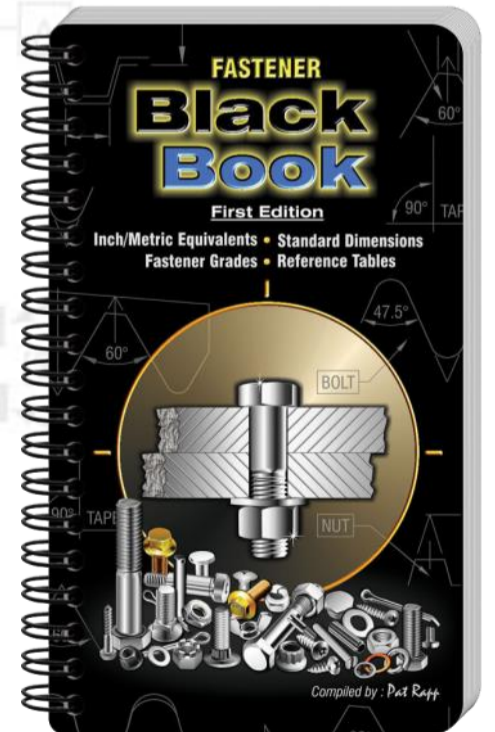

WE GO WHERE OTHERS FEAR TO THREAD

